

Schurch Asco SA

ASCO
Partenaire et Savoir-faire

AV. DU 1ER MARS 33, CP 3052
CH-2001 NEUCHÂTEL
SUISSE

TÉL : +41 32 724 3434
FAX : +41 32 724 3436
EMAIL : info@schurch-asco.com
WEB : www.schurch-asco.com

2. OUTILS DE COUPE

Foret pour l'horlogerie

HSS



YAMAMOTO MICRO DRILL

Pour matières formant des copeaux longs et courts.

Réf.	Ø PERÇAGE	L TOTALE	L UTILE	Ø TIGE	PRIX	Réf.	Ø PERÇAGE	L TOTALE	L UTILE	Ø TIGE	PRIX
Tolérance : Ø _{perçage} = + 0 / - 0.005						Tolérance : Ø _{perçage} = + 0 / - 0.005					
00010	0.10	19	0.6	1.0	6.90	00040	0.40	21	2.8	1.0	4.10
00011	0.11	19	0.7	1.0	6.90	00041	0.41	21	2.8	1.0	4.25
00012	0.12	19	0.7	1.0	6.90	00042	0.42	21	2.8	1.0	4.25
00013	0.13	19	0.9	1.0	5.75	00043	0.43	21	3.2	1.0	4.25
00014	0.14	19	1.0	1.0	5.75	00044	0.44	21	3.2	1.0	4.25
00015	0.15	19	1.0	1.0	5.75	00045	0.45	21	3.2	1.0	4.25
00016	0.16	20	1.1	1.0	5.05	00046	0.46	21	3.2	1.0	4.25
00017	0.17	20	1.1	1.0	5.05	00047	0.47	21	3.2	1.0	4.25
00018	0.18	20	1.2	1.0	5.05	00048	0.48	21	3.2	1.0	4.25
00019	0.19	20	1.2	1.0	5.05	00049	0.49	22	3.6	1.0	4.25
00020	0.20	20	1.4	1.0	4.55	00050	0.50	22	3.6	1.0	4.10
00021	0.21	20	1.4	1.0	4.75	00051	0.51	22	3.6	1.0	4.25
00022	0.22	20	1.6	1.0	4.75	00052	0.52	22	3.6	1.0	4.25
00023	0.23	20	1.6	1.0	4.75	00053	0.53	22	3.6	1.0	4.25
00024	0.24	20	1.6	1.0	4.75	00054	0.54	22	4.0	1.0	4.25
00025	0.25	20	1.8	1.0	4.75	00055	0.55	22	4.0	1.0	4.25
00026	0.26	20	2.0	1.0	4.75	00056	0.56	22	4.0	1.0	4.25
00027	0.27	20	2.0	1.0	4.75	00057	0.57	22	4.0	1.0	4.25
00028	0.28	20	2.0	1.0	4.75	00058	0.58	22	4.0	1.0	4.25
00029	0.29	20	2.2	1.0	4.75	00059	0.59	22	4.0	1.0	4.25
00030	0.30	20	2.2	1.0	4.40	00060	0.60	22	4.0	1.0	4.10
00031	0.31	21	2.2	1.0	4.60	00061	0.61	23	4.5	1.0	4.25
00032	0.32	21	2.2	1.0	4.60	00062	0.62	23	4.5	1.0	4.25
00033	0.33	21	2.2	1.0	4.60	00063	0.63	23	4.5	1.0	4.25
00034	0.34	21	2.2	1.0	4.60	00064	0.64	23	4.5	1.0	4.25
00035	0.35	21	2.5	1.0	4.60	00065	0.65	23	4.5	1.0	4.25
00036	0.36	21	2.5	1.0	4.60	00066	0.66	23	4.5	1.0	4.25
00037	0.37	21	2.5	1.0	4.60	00067	0.67	23	4.5	1.0	4.25
00038	0.38	21	2.5	1.0	4.60	00068	0.68	24	5.0	1.0	4.25
00039	0.39	21	2.8	1.0	4.60	00069	0.69	24	5.0	1.0	4.25

Conditions de vente : Rabais de 10% par commande de 100 pièces identiques.



Foret pour l'horlogerie

HSS

YAMAMOTO MICRO DRILL



Pour matières formant des copeaux longs et courts.

Réf.	Ø PERÇAGE	L TOTALE	L UTILE	Ø TIGE	PRIX
Tolérance : $\varnothing_{\text{perçage}} = + 0 / - 0.005$					
00070	0.70	24	5.0	1.0	4.10
00071	0.71	24	5.0	1.0	4.25
00072	0.72	24	5.0	1.0	4.25
00073	0.73	24	5.0	1.0	4.25
00074	0.74	25	5.6	1.0	4.25
00075	0.75	25	5.6	1.0	4.25
Tolérance : $\varnothing_{\text{perçage}} = + 0 / - 0.006$					
00076	0.76	25	5.6	1.5	4.55
00077	0.77	25	5.6	1.5	4.55
00078	0.78	25	5.6	1.5	4.55
00079	0.79	25	5.6	1.5	4.55
00080	0.80	25	5.6	1.5	4.40
00081	0.81	25	5.6	1.5	4.55
00082	0.82	25	5.6	1.5	4.55
00083	0.83	25	5.6	1.5	4.55
00084	0.84	25	5.6	1.5	4.55
00085	0.85	25	5.6	1.5	4.55
00086	0.86	25	6.3	1.5	4.55
00087	0.87	25	6.3	1.5	4.55
00088	0.88	25	6.3	1.5	4.55
00089	0.89	25	6.3	1.5	4.55
00090	0.90	25	6.3	1.5	4.25
00091	0.91	25	6.3	1.5	4.55
00092	0.92	25	6.3	1.5	4.55
00093	0.93	25	6.3	1.5	4.55
00094	0.94	25	6.3	1.5	4.55
00095	0.95	25	6.3	1.5	4.55
00096	0.96	25	7.1	1.5	4.55
00097	0.97	25	7.1	1.5	4.55
00098	0.98	25	7.1	1.5	4.55
00099	0.99	25	7.1	1.5	4.55

Réf.	Ø PERÇAGE	L TOTALE	L UTILE	Ø TIGE	PRIX
Tolérance : $\varnothing_{\text{perçage}} = + 0 / - 0.006$					
00100	1.00	25	7.1	1.5	4.25
00101	1.01	25	7.1	1.5	4.55
00102	1.02	25	7.1	1.5	4.55
00103	1.03	25	7.1	1.5	4.55
00104	1.04	25	7.1	1.5	4.55
00105	1.05	25	7.1	1.5	4.55
00106	1.06	25	7.1	1.5	4.55
00107	1.07	26	8.0	1.5	4.55
00108	1.08	26	8.0	1.5	4.55
00109	1.09	26	8.0	1.5	4.55
00110	1.10	26	8.0	1.5	4.25
00111	1.11	26	8.0	1.5	4.55
00112	1.12	26	8.0	1.5	4.55
00113	1.13	26	8.0	1.5	4.55
00114	1.14	26	8.0	1.5	4.55
00115	1.15	26	8.0	1.5	4.55
00116	1.16	26	8.0	1.5	4.55
00117	1.17	26	8.0	1.5	4.55
00118	1.18	26	8.0	1.5	4.55
00119	1.19	27	9.0	1.5	4.55
00120	1.20	27	9.0	1.5	4.25
00121	1.21	27	9.0	1.5	4.55
00122	1.22	27	9.0	1.5	4.55
00123	1.23	27	9.0	1.5	4.55
00124	1.24	27	9.0	1.5	4.55
00125	1.25	27	9.0	1.5	4.55
00130	1.30	27	9.0	1.5	4.25
Tolérance : $\varnothing_{\text{perçage}} = + 0 / - 0.008$					
00135	1.35	28	10.0	2.0	5.05
00140	1.40	28	10.0	2.0	4.85
00145	1.45	28	10.0	2.0	5.05
00150	1.50	28	10.0	2.0	4.85

Conditions de vente : Rabais de 10% par commande de 100 pièces identiques.

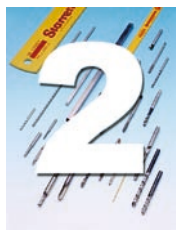

Schurch Asco SA

ASCO
Partenaire et Savoir-faire

AV. DU 1ER MARS 33, CP 3052
CH-2001 NEUCHÂTEL
SUISSE

TÉL : +41 32 724 3434
FAX : +41 32 724 3436
EMAIL : info@schurch-asco.com
WEB : www.schurch-asco.com

Foret pour l'horlogerie

coupe à droite, hélice à 24°, pointe à 118°



MD

1131 R

Pour matières formant des copeaux longs et courts.

Réf.	Ø PERÇAGE	L TOTALE	L UTILE	Ø TIGE	PRIX
Tolérance : Ø _{perçage} = + 0 / - 0.004 Ø _{tige} = h6					
08010	0.10	30	0.7	1.0	15.50
08011	0.11	30	0.7	1.0	15.00
08012	0.12	30	0.7	1.0	15.00
08013	0.13	30	0.7	1.0	15.00
08014	0.14	30	0.7	1.0	15.00
08015	0.15	30	1.0	1.0	13.60
08016	0.16	30	1.0	1.0	14.60
08017	0.17	30	1.0	1.0	14.60
08018	0.18	30	1.0	1.0	14.60
08019	0.19	30	1.0	1.0	14.60
08020	0.20	30	1.0	1.0	11.20
08021	0.21	30	1.0	1.0	13.10
08022	0.22	30	1.0	1.0	13.10
08023	0.23	30	1.0	1.0	13.10
08024	0.24	30	1.0	1.0	13.10
08025	0.25	30	1.0	1.0	11.20
08026	0.26	30	1.0	1.0	13.10
08027	0.27	30	1.0	1.0	13.10
08028	0.28	30	1.0	1.0	13.10
08029	0.29	30	1.0	1.0	13.10
08030	0.30	30	1.5	1.0	11.30
08031	0.31	30	1.5	1.0	13.10
08032	0.32	30	1.5	1.0	13.10
08033	0.33	30	1.5	1.0	13.10
08034	0.34	30	1.5	1.0	13.10
08035	0.35	30	1.5	1.0	10.10
08036	0.36	30	1.5	1.0	13.10
08037	0.37	30	1.5	1.0	13.10
08038	0.38	30	1.5	1.0	13.10
08039	0.39	30	1.5	1.0	13.10

Réf.	Ø PERÇAGE	L TOTALE	L UTILE	Ø TIGE	PRIX
Tolérance : Ø _{perçage} = + 0 / - 0.004 Ø _{tige} = h6					
08040	0.40	30	2.0	1	10.10
08041	0.41	30	2.0	1	13.10
08042	0.42	30	2.0	1	13.10
08043	0.43	30	2.0	1	13.10
08044	0.44	30	2.0	1	13.10
08045	0.45	30	3.6	1	9.10
08046	0.46	30	3.6	1	13.10
08047	0.47	30	3.6	1	13.10
08048	0.48	30	3.6	1	13.10
08049	0.49	30	4.0	1	13.10
08050	0.50	30	4.0	1	9.10
08051	0.51	30	4.0	1	13.10
08052	0.52	30	4.0	1	13.10
08053	0.53	30	4.0	1	13.10
08054	0.54	30	4.5	1	13.10
08055	0.55	30	4.5	1	9.10
08056	0.56	30	4.5	1	13.10
08057	0.57	30	4.5	1	13.10
08058	0.58	30	4.5	1	13.10
08059	0.59	30	4.5	1	13.10
08060	0.60	30	4.5	1	9.10
08061	0.61	30	5.0	1	13.10
08062	0.62	30	5.0	1	13.10
08063	0.63	30	5.0	1	13.10
08064	0.64	30	5.0	1	13.10
08065	0.65	30	5.0	1	9.10
08066	0.66	30	5.0	1	13.10
08067	0.67	30	5.0	1	13.10
08068	0.68	30	5.6	1	13.10
08069	0.69	30	5.6	1	13.10

Conditions de vente, rabais par dimensions :
 5% pour 10 pièces identiques
 10% pour 30 pièces identiques
 15% pour 50 pièces identiques



Foret pour l'horlogerie

coupe à droite, hélice à 24°, pointe à 118°

MD

1131 R



Pour matières formant des copeaux longs et courts.

Réf.	Ø PERÇAGE	L TOTALE	L UTILE	Ø TIGE	PRIX
Tolérance : Ø _{perçage} = + 0 / - 0.004		Ø _{tige} = h6			
08070	0.70	30	5.60	1.0	9.10
08071	0.71	30	5.60	1.0	13.10
08072	0.72	30	5.60	1.0	13.10
08073	0.73	30	5.60	1.0	13.10
08074	0.74	30	5.60	1.0	13.10
08075	0.75	30	5.60	1.0	8.70
08076	0.76	30	6.30	1.0	13.10
08077	0.77	30	6.30	1.0	13.10
08078	0.78	30	6.30	1.0	13.10
08079	0.79	30	6.30	1.0	13.10
08080	0.80	30	6.30	1.5	8.70
08081	0.81	30	6.30	1.5	14.20
08082	0.82	30	6.30	1.5	14.20
08083	0.83	30	6.30	1.5	14.20
08084	0.84	30	6.30	1.5	14.20
08085	0.85	30	6.30	1.5	8.70
08086	0.86	30	7.25	1.5	14.20
08087	0.87	30	7.25	1.5	14.20
08088	0.88	30	7.25	1.5	14.20
08089	0.89	30	7.25	1.5	14.20
08090	0.90	30	7.25	1.5	8.70
08091	0.91	30	7.25	1.5	14.20
08092	0.92	30	7.25	1.5	14.20
08093	0.93	30	7.25	1.5	14.20
08094	0.94	30	7.25	1.5	14.20
08095	0.95	30	7.25	1.5	8.70
08096	0.96	30	8.00	1.5	14.20
08097	0.97	30	8.00	1.5	14.20
08098	0.98	30	8.00	1.5	14.20
08099	0.99	30	8.00	1.5	14.20

Conditions de vente :

Rabais par dimensions :

5 % pour 10 pièces identiques

10% pour 30 pièces identiques

15% pour 50 pièces identiques

Janvier 2024

Réf.	Ø PERÇAGE	L TOTALE	L UTILE	Ø TIGE	PRIX
Tolérance : Ø _{perçage} = + 0 / - 0.004		Ø _{tige} = h6			
08100	1.00	30	9.00	1.5	12.20
08101	1.01	30	9.0	1.5	14.30
08102	1.02	30	9.0	1.5	14.30
08103	1.03	30	9.0	1.5	14.30
08104	1.04	30	9.0	1.5	14.30
08105	1.05	30	9.0	1.5	12.90
08106	1.06	30	9.0	1.5	14.30
08107	1.07	30	9.0	1.5	14.30
08108	1.08	30	9.0	1.5	14.30
08109	1.09	30	9.0	1.5	14.30
08110	1.10	30	9.0	1.5	12.20
08111	1.11	30	9.0	1.5	14.30
08112	1.12	30	9.0	1.5	14.30
08113	1.13	30	9.0	1.5	14.30
08114	1.14	30	9.0	1.5	14.30
08115	1.15	30	9.0	1.5	12.90
08116	1.16	30	9.0	1.5	14.30
08117	1.17	30	9.0	1.5	14.30
08118	1.18	30	9.0	1.5	14.30
08119	1.19	30	10.0	1.5	14.30
08120	1.20	30	10.0	1.5	12.20
08121	1.21	30	10.0	1.5	14.30
08122	1.22	30	10.0	1.5	14.30
08123	1.23	30	10.0	1.5	14.30
08124	1.24	30	10.0	1.5	14.30
08125	1.25	30	10.0	1.5	12.90
08130	1.30	30	10.0	1.5	12.20
08135	1.35	30	11.2	1.5	12.90
08140	1.40	30	11.2	1.5	12.20
08145	1.45	30	11.2	1.5	12.90
08150	1.50	38	11.2	2.0	15.70
08155	1.55	38	12.0	2.0	15.70
08160	1.60	38	12.0	2.0	15.70

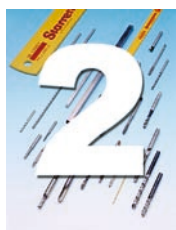

Schurch Asco SA



Partenaire et Savoir-faire

AV. DU 1ER MARS 33, CP 3052
CH-2001 NEUCHÂTEL
SUISSE

TÉL : +41 32 724 3434
FAX : +41 32 724 3436
EMAIL : info@schurch-asco.com
WEB : www.schurch-asco.com

Foret pour l'horlogerie

coupe à droite

HSSE à revêtement TIN

YAMAMOTO MICRO DRILL



Le revêtement TIN allonge la durée de vie.
Les articles notés en rouge sont disponibles du stock.
Utilisation : acier à résistance élevée, inox, bronze, etc.

Réf.	Ø PERÇAGE	L TOTALE	L UTILE	Ø TIGE	PRIX
Tolérance : Ø _{perçage} = + 0 / - 0.005					
10010	0.10	19	0.6	1.0	12.55
10011	0.11	19	0.7	1.0	12.55
10012	0.12	19	0.7	1.0	12.55
10013	0.13	19	0.9	1.0	11.40
10014	0.14	19	1.0	1.0	11.40
10015	0.15	19	1.0	1.0	11.40
10016	0.16	20	1.1	1.0	10.70
10017	0.17	20	1.1	1.0	10.70
10018	0.18	20	1.2	1.0	10.70
10019	0.19	20	1.2	1.0	10.70
10020	0.20	20	1.4	1.0	10.20
10021	0.21	20	1.4	1.0	10.40
10022	0.22	20	1.6	1.0	10.40
10023	0.23	20	1.6	1.0	10.40
10024	0.24	20	1.6	1.0	10.40
10025	0.25	20	1.8	1.0	10.40
10026	0.26	20	2.0	1.0	10.40
10027	0.27	20	2.0	1.0	10.40
10028	0.28	20	2.0	1.0	10.40
10029	0.29	20	2.2	1.0	10.40
10030	0.30	20	2.2	1.0	10.05
10031	0.31	21	2.2	1.0	10.25
10032	0.32	21	2.2	1.0	10.25
10033	0.33	21	2.2	1.0	10.25
10034	0.34	21	2.2	1.0	10.25
10035	0.35	21	2.5	1.0	10.25
10036	0.36	21	2.5	1.0	10.25
10037	0.37	21	2.5	1.0	10.25
10038	0.38	21	2.5	1.0	10.25
10039	0.39	21	2.8	1.0	10.25

Réf.	Ø PERÇAGE	L TOTALE	L UTILE	Ø TIGE	PRIX
Tolérance : Ø _{perçage} = + 0 / - 0.005					
10040	0.40	21	2.8	1.0	9.75
10041	0.41	21	2.8	1.0	9.90
10042	0.42	21	2.8	1.0	9.90
10043	0.43	21	3.2	1.0	9.90
10044	0.44	21	3.2	1.0	9.90
10045	0.45	21	3.2	1.0	9.90
10046	0.46	21	3.2	1.0	9.90
10047	0.47	21	3.2	1.0	9.90
10048	0.48	21	3.2	1.0	9.90
10049	0.49	22	3.6	1.0	9.90
10050	0.50	22	3.6	1.0	9.75
10051	0.51	22	3.6	1.0	9.90
10052	0.52	22	3.6	1.0	9.90
10053	0.53	22	3.6	1.0	9.90
10054	0.54	22	4.0	1.0	9.90
10055	0.55	22	4.0	1.0	9.90
10056	0.56	22	4.0	1.0	9.90
10057	0.57	22	4.0	1.0	9.90
10058	0.58	22	4.0	1.0	9.90
10059	0.59	22	4.0	1.0	9.90
10060	0.60	22	4.0	1.0	9.75
10061	0.61	23	4.5	1.0	9.90
10062	0.62	23	4.5	1.0	9.90
10063	0.63	23	4.5	1.0	9.90
10064	0.64	23	4.5	1.0	9.90
10065	0.65	23	4.5	1.0	9.90
10066	0.66	23	4.5	1.0	9.90
10067	0.67	23	4.5	1.0	9.90
10068	0.68	24	5.0	1.0	9.90
10069	0.69	24	5.0	1.0	9.90

Conditions de vente, rabais par dimensions : 5% pour 10 pièces identiques
10% pour 30 pièces identiques
15% pour 50 pièces identiques



Foret pour l'horlogerie

coupe à droite

HSSE à revêtement TIN

YAMAMOTO MICRO DRILL



Le revêtement TIN allonge la durée de vie.
Les articles notés en rouge sont disponibles du stock.
Utilisation : acier à résistance élevée, inox, bronze, etc.

Réf.	Ø PERÇAGE	L TOTALE	L UTILE	Ø TIGE	PRIX
Tolérance : $\varnothing_{\text{perçage}} = + 0 / - 0.005$					
10070	0.70	24	5.0	1.0	9.75
10071	0.71	24	5.0	1.0	9.90
10072	0.72	24	5.0	1.0	9.90
10073	0.73	24	5.0	1.0	9.90
10074	0.74	25	5.6	1.0	9.90
10075	0.75	25	5.6	1.0	9.90
Tolérance : $\varnothing_{\text{perçage}} = + 0 / - 0.006$					
10076	0.76	25	5.6	1.5	10.20
10077	0.77	25	5.6	1.5	10.20
10078	0.78	25	5.6	1.5	10.20
10079	0.79	25	5.6	1.5	10.20
10080	0.80	25	5.6	1.5	10.05
10081	0.81	25	5.6	1.5	10.20
10082	0.82	25	5.6	1.5	10.20
10083	0.83	25	5.6	1.5	10.20
10084	0.84	25	5.6	1.5	10.20
10085	0.85	25	5.6	1.5	10.20
10086	0.86	25	6.3	1.5	10.20
10087	0.87	25	6.3	1.5	10.20
10088	0.88	25	6.3	1.5	10.20
10089	0.89	25	6.3	1.5	10.20
10090	0.90	25	6.3	1.5	9.90
10091	0.91	25	6.3	1.5	10.20
10092	0.92	25	6.3	1.5	10.20
10093	0.93	25	6.3	1.5	10.20
10094	0.94	25	6.3	1.5	10.20
10095	0.95	25	6.3	1.5	10.20
10096	0.96	25	7.1	1.5	10.20
10097	0.97	25	7.1	1.5	10.20
10098	0.98	25	7.1	1.5	10.20
10099	0.99	25	7.1	1.5	10.20

Réf.	Ø PERÇAGE	L TOTALE	L UTILE	Ø TIGE	PRIX
Tolérance : $\varnothing_{\text{perçage}} = + 0 / - 0.006$					
10100	1.00	25	7.1	1.5	9.90
10101	1.01	25	7.1	1.5	10.20
10102	1.02	25	7.1	1.5	10.20
10103	1.03	25	7.1	1.5	10.20
10104	1.04	25	7.1	1.5	10.20
10105	1.05	25	7.1	1.5	10.20
10106	1.06	25	7.1	1.5	10.20
10107	1.07	26	8.0	1.5	9.70
10108	1.08	26	8.0	1.5	9.70
10109	1.09	26	8.0	1.5	9.70
10110	1.10	26	8.0	1.5	9.40
10111	1.11	26	8.0	1.5	9.70
10112	1.12	26	8.0	1.5	9.70
10113	1.13	26	8.0	1.5	9.70
10114	1.14	26	8.0	1.5	9.70
10115	1.15	26	8.0	1.5	9.70
10116	1.16	26	8.0	1.5	9.70
10117	1.17	26	8.0	1.5	9.70
10118	1.18	26	8.0	1.5	9.70
10119	1.19	27	9.0	1.5	9.70
10120	1.20	27	9.0	1.5	9.40
10121	1.21	27	9.0	1.5	9.70
10122	1.22	27	9.0	1.5	9.70
10123	1.23	27	9.0	1.5	9.70
10124	1.24	27	9.0	1.5	9.70
10125	1.25	27	9.0	1.5	9.40
10130	1.30	27	9.0	1.5	9.40
Tolérance : $\varnothing_{\text{perçage}} = + 0 / - 0.008$					
10135	1.35	28	10.0	2.0	10.20
10140	1.40	28	10.0	2.0	10.00
10145	1.45	28	10.0	2.0	10.20
10150	1.50	28	10.0	2.0	10.00

Conditions de vente, rabais par dimensions :
 5% pour 10 pièces identiques
 10% pour 30 pièces identiques
 15% pour 50 pièces identiques

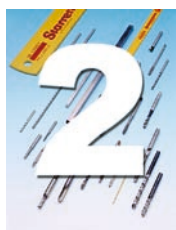

Schurch Asco SA

ASCO
Partenaire et Savoir-faire

AV. DU 1ER MARS 33, CP 3052
CH-2001 NEUCHÂTEL
SUISSE

TÉL : +41 32 724 3434
FAX : +41 32 724 3436
EMAIL : info@schurch-asco.com
WEB : www.schurch-asco.com

Foret pour l'horlogerie

coupe à droite, hélice à 24°, pointe à 118°

MD à revêtement TIN

1131 R



Le revêtement TIN allonge la durée de vie.
Les articles notés en rouge sont disponibles du stock.
Utilisation : acier à résistance élevée, inox, bronze, etc.

Réf.	Ø PERÇAGE	L TOTALE	L UTILE	Ø TIGE	PRIX
Tolérance : Ø _{perçage} = + 0 / - 0.004 Ø _{tige} = h6					
11010	0.10	30	0.7	1.0	23.70
11011	0.11	30	0.7	1.0	23.20
11012	0.12	30	0.7	1.0	23.20
11013	0.13	30	0.7	1.0	23.20
11014	0.14	30	0.7	1.0	23.20
11015	0.15	30	1.0	1.0	21.80
11016	0.16	30	1.0	1.0	22.80
11017	0.17	30	1.0	1.0	22.80
11018	0.18	30	1.0	1.0	22.80
11019	0.19	30	1.0	1.0	22.80
11020	0.20	30	1.0	1.0	16.00
11021	0.21	30	1.0	1.0	18.10
11022	0.22	30	1.0	1.0	18.10
11023	0.23	30	1.0	1.0	18.10
11024	0.24	30	1.0	1.0	18.10
11025	0.25	30	1.0	1.0	16.00
11026	0.26	30	1.0	1.0	18.10
11027	0.27	30	1.0	1.0	18.10
11028	0.28	30	1.0	1.0	18.10
11029	0.29	30	1.0	1.0	18.10
11030	0.30	30	1.5	1.0	16.10
11031	0.31	30	1.5	1.0	18.10
11032	0.32	30	1.5	1.0	18.10
11033	0.33	30	1.5	1.0	18.10
11034	0.34	30	1.5	1.0	18.10
11035	0.35	30	1.5	1.0	15.00
11036	0.36	30	1.5	1.0	18.10
11037	0.37	30	1.5	1.0	18.10
11038	0.38	30	1.5	1.0	18.10
11039	0.39	30	1.5	1.0	18.10

Réf.	Ø PERÇAGE	L TOTALE	L UTILE	Ø TIGE	PRIX
Tolérance : Ø _{perçage} = + 0 / - 0.004 Ø _{tige} = h6					
11040	0.40	30	2.0	1.0	15.00
11041	0.41	30	2.0	1.0	18.10
11042	0.42	30	2.0	1.0	18.10
11043	0.43	30	2.0	1.0	18.10
11044	0.44	30	2.0	1.0	18.10
11045	0.45	30	3.6	1.0	14.10
11046	0.46	30	3.6	1.0	18.10
11047	0.47	30	3.6	1.0	18.10
11048	0.48	30	3.6	1.0	18.10
11049	0.49	30	4.0	1.0	18.10
11050	0.50	30	4.0	1.0	14.10
11051	0.51	30	4.0	1.0	18.10
11052	0.52	30	4.0	1.0	18.10
11053	0.53	30	4.0	1.0	18.10
11054	0.54	30	4.5	1.0	18.10
11055	0.55	30	4.5	1.0	14.10
11056	0.56	30	4.5	1.0	18.10
11057	0.57	30	4.5	1.0	18.10
11058	0.58	30	4.5	1.0	18.10
11059	0.59	30	4.5	1.0	18.10
11060	0.60	30	4.5	1.0	14.10
11061	0.61	30	5.0	1.0	18.10
11062	0.62	30	5.0	1.0	18.10
11063	0.63	30	5.0	1.0	18.10
11064	0.64	30	5.0	1.0	18.10
11065	0.65	30	5.0	1.0	14.10
11066	0.66	30	5.0	1.0	18.10
11067	0.67	30	5.0	1.0	18.10
11068	0.68	30	5.6	1.0	18.10
11069	0.69	30	5.6	1.0	18.10

Conditions de vente, rabais par dimensions :
5% pour 10 pièces identiques
10% pour 30 pièces identiques
15% pour 50 pièces identiques



Foret pour l'horlogerie

coupe à droite, hélice à 24°, pointe à 118°

MD à revêtement TIN

1131 R



Le revêtement TIN allonge la durée de vie.
Les articles notés en rouge sont disponibles du stock.
Utilisation : acier à résistance élevée, inox, bronze, etc.

Réf.	Ø PERÇAGE	L TOTALE	L UTILE	Ø TIGE	PRIX
Tolérance : Ø _{perçage} = + 0 / - 0.004 Ø _{tige} = h6					
11070	0.70	30	5.6	1.0	14.10
11071	0.71	30	5.6	1.0	18.10
11072	0.72	30	5.6	1.0	18.10
11073	0.73	30	5.6	1.0	18.10
11074	0.74	30	5.6	1.0	18.10
11075	0.75	30	5.6	1.0	13.60
11076	0.76	30	6.3	1.0	18.10
11077	0.77	30	6.3	1.0	18.10
11078	0.78	30	6.3	1.0	18.10
11079	0.79	30	6.3	1.0	18.10
11080	0.80	30	6.3	1.5	13.60
11081	0.81	30	6.3	1.5	19.10
11082	0.82	30	6.3	1.5	19.10
11083	0.83	30	6.3	1.5	19.10
11084	0.84	30	6.3	1.5	19.10
11085	0.85	30	6.3	1.5	13.60
11086	0.86	30	7.1	1.5	19.10
11087	0.87	30	7.1	1.5	19.10
11088	0.88	30	7.1	1.5	19.10
11089	0.89	30	7.1	1.5	19.10
11090	0.90	30	7.1	1.5	13.60
11091	0.91	30	7.1	1.5	19.10
11092	0.92	30	7.1	1.5	19.10
11093	0.93	30	7.1	1.5	19.10
11094	0.94	30	7.1	1.5	19.10
11095	0.95	30	7.1	1.5	13.60
11096	0.96	30	8.0	1.5	19.10
11097	0.97	30	8.0	1.5	19.10
11098	0.98	30	8.0	1.5	19.10
11099	0.99	30	8.0	1.5	19.10

Réf.	Ø PERÇAGE	L TOTALE	L UTILE	Ø TIGE	PRIX
Tolérance : Ø _{perçage} = + 0 / - 0.004 Ø _{tige} = h6					
11100	1.00	30	9.0	1.5	17.10
11101	1.01	30	9.0	1.5	19.20
11102	1.02	30	9.0	1.5	19.20
11103	1.03	30	9.0	1.5	19.20
11104	1.04	30	9.0	1.5	19.20
11105	1.05	30	9.0	1.5	17.80
11106	1.06	30	9.0	1.5	19.20
11107	1.07	30	9.0	1.5	19.20
11108	1.08	30	9.0	1.5	19.20
11109	1.09	30	9.0	1.5	19.20
11110	1.10	30	9.0	1.5	17.10
11111	1.11	30	9.0	1.5	19.20
11112	1.12	30	9.0	1.5	19.20
11113	1.13	30	9.0	1.5	19.20
11114	1.14	30	9.0	1.5	19.20
11115	1.15	30	9.0	1.5	17.80
11116	1.16	30	9.0	1.5	19.20
11117	1.17	30	9.0	1.5	19.20
11118	1.18	30	9.0	1.5	19.20
11119	1.19	30	10.0	1.5	19.20
11120	1.20	30	10.0	1.5	17.10
11121	1.21	30	10.0	1.5	19.20
11122	1.22	30	10.0	1.5	19.20
11123	1.23	30	10.0	1.5	19.20
11124	1.24	30	10.0	1.5	19.20
11125	1.25	30	10.0	1.5	17.80
11130	1.30	30	10.0	1.5	17.10
11135	1.35	30	11.2	1.5	17.80
11140	1.40	30	11.2	1.5	17.10
11145	1.45	30	11.2	1.5	17.80
11150	1.50	38	11.2	2.0	20.70
11155	1.55	38	12.0	2.0	20.70
11160	1.60	38	12.0	2.0	20.70

Conditions de vente, rabais par dimensions :
5% pour 10 pièces identiques
10% pour 30 pièces identiques
15% pour 50 pièces identiques

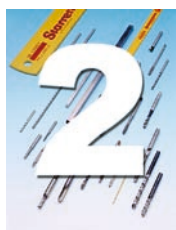

Schurch Asco SA



Partenaire et Savoir-faire

AV. DU 1ER MARS 33, CP 3052
CH-2001 NEUCHÂTEL
SUISSE

TÉL : +41 32 724 3434
FAX : +41 32 724 3436

EMAIL : info@schurch-asco.com
WEB : www.schurch-asco.com

Foret ASCO

3 lèbres

MD, Haute performance, 130°

385



Ce foret garantit un perçage de qualité supérieure en état de surface, en tolérance de centrage et de circularité.

Tige : Ø tige = 3.175 = 1/8 "

Réf.	Ø PERÇAGE	L TOTALE	L UTILE	PRIX	Réf.	Ø PERÇAGE	L TOTALE	L UTILE	PRIX
01441	0.150	38	2.0	28.05	01468	1.500	38	10.5	12.85
01442	0.200	38	3.0	25.15	01469	1.600	38	10.5	12.85
01443	0.250	38	3.5	21.20	01470	1.700	38	10.5	12.85
01444	0.300	38	5.0	18.55	01471	1.800	38	10.5	12.85
01445	0.350	38	5.0	18.55	01486	1.850	38	10.5	12.85
01446	0.400	38	6.0	18.55	01472	1.900	38	10.5	12.85
01447	0.450	38	6.0	18.55					
					01473	2.000	38	10.5	12.85
01448	0.500	38	6.0	18.55	01474	2.100	38	10.5	12.85
01449	0.550	38	7.0	12.85	01475	2.200	38	10.5	12.85
01450	0.600	38	7.0	12.85	01476	2.300	38	10.5	12.85
01451	0.650	38	7.0	12.85	01477	2.400	38	10.5	12.85
01452	0.700	38	9.5	12.85					
01453	0.750	38	9.5	12.85	01478	2.500	38	10.5	12.85
01454	0.800	38	9.5	12.85	01479	2.600	38	10.5	12.85
01455	0.850	38	9.5	12.85	01480	2.700	38	10.5	12.85
01456	0.900	38	9.5	12.85	01481	2.800	38	10.5	12.85
01457	0.950	38	9.5	12.85	01482	2.900	38	10.5	12.85
01458	1.000	38	10.5	12.85	01483	3.000	38	10.5	12.85
01459	1.050	38	10.5	12.85	01484	3.100	38	10.5	12.85
01460	1.100	38	10.5	12.85	01485	3.175	38	10.5	12.85
01461	1.150	38	10.5	12.85					
01462	1.200	38	10.5	12.85					
01463	1.250	38	10.5	12.85					
01464	1.300	38	10.5	12.85					
01465	1.350	38	10.5	12.85					
01466	1.400	38	10.5	12.85					
01467	1.450	38	10.5	12.85					

Conditions de vente, rabais par dimensions : 5% pour 10 pièces identiques
10% pour 30 pièces identiques
15% pour 50 pièces identiques



coupe à droite, hélice à 35°, pointe à 90°

1135 R

Utilisation : acier à résistance élevée, inox, bronze, etc.
Le revêtement TIN allonge la durée de vie.

MD



Réf.	Ø PERÇAGE	L TOTALE	L UTILE	Ø TIGE	PRIX
Tolérance : Ø _{perçage} = + 0 / - 0.004 Ø _{tige} = h6					
14161	1.60	38	7.0	2.0	16.90
14181	1.80		8.0		16.90

1111 R

Utilisation : matières formant des copeaux longs et courts

Réf.	Ø PERÇAGE	L TOTALE	L UTILE	Ø TIGE	PRIX
Tolérance : Ø _{perçage} = + 0 / - 0.004 Ø _{tige} = h6					
16170	0.50	30	3.0	1.50	13.20
16175	0.80		5.0		14.20
16180	1.00		9.0		14.20

Réf.	Ø PERÇAGE	L TOTALE	L UTILE	Ø TIGE	PRIX
08170	0.50	30	1.0	1.50	12.50
08171	0.55		1.0		12.50
08172	0.60		1.2		12.50
08173	0.65		1.2		12.50
08174	0.70		1.5		12.50
08175	0.75		1.5		12.50
08176	0.80		2.0		12.20
08177	0.85				12.20
08178	0.90				12.20
08179	0.95				12.20
08180	1.00				12.20
08181	1.05				12.20
08182	1.10		2.4		12.20
08183	1.15				12.20
08184	1.20				12.20
08185	1.25	12.20			
08186	1.30	12.20			
08187	1.35	12.20			
08188	1.40	12.20			
08189	1.45	12.20			

Foret ASCO type court

pour Sertissage

MD + TIN



Réf.	Ø PERÇAGE	L TOTALE	L UTILE	Ø TIGE	PRIX
Tolérance : Ø _{perçage} = + 0 / - 0.004 Ø _{tige} = h6					
15161	1.60	38	7.0	2.0	21.70
15181	1.80		8.0		21.70

Mèche pour centrage

MD, 1 lèvre



Conditions de vente : Rabais par dimensions : 5% pour 10 pièces identiques
10% pour 30 pièces identiques
15% pour 50 pièces identiques

Foret ASCO type court

coupe à droite, hélice à 35°, pointe à 120°

MD, pour pointage

1109 R

Utilisation : pointage de trou. mitraillage pour sertissage dans alu. cuivre. platine et acier inox.



Conditions de vente : Prix net.

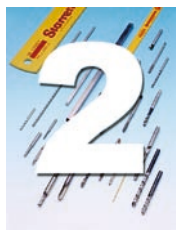

Schurch Asco SA

ASCO
Partenaire et Savoir-faire

AV. DU 1ER MARS 33, CP 3052
CH-2001 NEUCHÂTEL
SUISSE

TÉL : +41 32 724 3434
FAX : +41 32 724 3436
EMAIL : info@schurch-asco.com
WEB : www.schurch-asco.com

Foret ASCO

1134 R

coupe à droite, hélice à 35°, pointe à 120°

Le revêtement TIN allonge la durée de vie.

Utilisation : acier à résistance élevée, inox, bronze, etc.

MD

MD + TIN



Réf.	Ø PERÇAGE	L TOTALE	L UTILE	Ø TIGE	PRIX
Tolérance : Ø _{perçage} = + 0 / - 0.004 Ø _{tige} = h6					
12050	0.50	30	4.00	1.0	13.30
12055	0.55	30	4.50	1.0	13.30
12060	0.60	30	4.50	1.0	13.30
12065	0.65	30	5.00	1.0	13.30
12070	0.70	30	5.60	1.0	13.30
12075	0.75	30	5.60	1.0	13.30
12080	0.80	30	6.30	1.5	13.30
12085	0.85	30	6.30	1.5	13.30
12090	0.90	30	7.10	1.5	13.30
12095	0.95	30	7.10	1.5	13.30
12100	1.00	30	9.00	1.5	13.30
12105	1.05	30	9.00	1.5	13.30
12110	1.10	30	9.00	1.5	13.30
12115	1.15	30	9.00	1.5	13.30
12120	1.20	30	10.00	1.5	13.30
12125	1.25	30	10.00	1.5	13.30
12130	1.30	30	10.00	1.5	13.30
12135	1.35	30	11.20	1.5	13.30
12140	1.40	30	11.20	1.5	13.30
12145	1.45	30	11.20	1.5	13.30
12150	1.50	38	11.20	2.0	13.30
12155	1.55	38	12.00	2.0	17.30
12160	1.60	38	12.00	2.0	17.30
12165	1.65	38	12.00	2.0	17.30
12170	1.70	38	12.00	2.0	17.30
12175	1.75	38	12.00	2.0	17.30
12180	1.80	38	12.00	2.0	17.30
12185	1.85	38	12.00	2.0	17.30
12190	1.90	38	12.00	2.0	17.30
12195	1.95	38	12.00	2.0	17.30

Réf.	Ø PERÇAGE	L TOTALE	L UTILE	Ø TIGE	PRIX
Tolérance : Ø _{perçage} = + 0 / - 0.004 Ø _{tige} = h6					
13050	0.50	30	4.0	1.0	18.30
13055	0.55	30	4.5	1.0	18.30
13060	0.60	30	4.5	1.0	18.30
13065	0.65	30	5.0	1.0	18.30
13070	0.70	30	5.6	1.0	18.30
13075	0.75	30	5.6	1.0	18.30
13080	0.80	30	6.3	1.5	18.30
13085	0.85	30	6.3	1.5	18.30
13090	0.90	30	7.1	1.5	18.30
13095	0.95	30	7.1	1.5	18.30
13100	1.00	30	9.0	1.5	18.30
13105	1.05	30	9.0	1.5	18.30
13110	1.10	30	9.0	1.5	18.30
13115	1.15	30	9.0	1.5	18.30
13120	1.20	30	10.0	1.5	18.30
13125	1.25	30	10.0	1.5	18.30
13130	1.30	30	10.0	1.5	18.30
13135	1.35	30	11.2	1.5	18.30
13140	1.40	30	11.2	1.5	18.30
13145	1.45	30	11.2	1.5	18.30
13150	1.50	38	11.2	2.0	18.30
13155	1.55	38	12.0	2.0	22.20
13160	1.60	38	12.0	2.0	22.20
13165	1.65	38	12.0	2.0	22.20
13170	1.70	38	12.0	2.0	22.20
13175	1.75	38	12.0	2.0	22.20
13180	1.80	38	12.0	2.0	22.20
13185	1.85	38	12.0	2.0	22.20
13190	1.90	38	12.0	2.0	22.20
13195	1.95	38	12.0	2.0	22.20

Conditions de vente, rabais par dimensions :
 5% pour 10 pièces identiques
 10% pour 30 pièces identiques
 15% pour 50 pièces identiques



Foret ASCO type court

1135 R

coupe à droite, hélice à 35°, pointe à 120°

Pour alliage dur AISi
Le revêtement TIN allonge la durée de vie.

Utilisation : acier à résistance élevée, inox, bronze, etc.

MD

MD + TIN



Réf.	Ø PERÇAGE	L TOTALE	L UTILE	Ø TIGE	PRIX
Tolérance : Ø _{perçage} = + 0 / - 0.004					Ø _{tige} = h6
14060	0.60	30	4.5	1.5	13.30
14070	0.70	30	4.5	1.5	13.30
14075	0.75	30	4.5	1.5	13.30
14080	0.80	30	5.0	1.5	13.30
14085	0.85	30	5.0	1.5	13.30
14090	0.90	30	5.0	1.5	13.30
14091	0.91	30	5.0	1.5	13.30
14094	0.94	30	5.0	1.5	13.30
14095	0.95	30	5.0	1.5	13.30
14100	1.00	30	5.0	1.5	13.30
14104	1.04	30	5.0	1.5	13.30
14105	1.05	30	5.0	1.5	13.30
14110	1.10	30	5.0	1.5	13.30
14115	1.15	30	5.0	1.5	13.30
14120	1.20	30	6.0	1.5	13.30
14125	1.25	30	6.0	1.5	13.30
14130	1.30	30	6.0	1.5	13.30
14135	1.35	30	6.0	1.5	13.30
14140	1.40	30	6.0	1.5	13.30
14145	1.45	30	6.0	1.5	13.30
14148	1.48	30	6.0	1.5	13.30
14150	1.50	38	7.0	2.0	17.30
14155	1.55	38	7.0	2.0	17.30
14158	1.58	38	7.0	2.0	17.30
14160	1.60	38	7.0	2.0	17.30
14165	1.65	38	7.0	2.0	17.30
14170	1.70	38	7.0	2.0	17.30
14175	1.75	38	7.0	2.0	17.30
14178	1.78	38	8.0	2.0	17.30
14180	1.80	38	8.0	2.0	17.30
14185	1.85	38	8.0	2.0	17.30
14190	1.90	38	8.0	2.0	17.30

Réf.	Ø PERÇAGE	L TOTALE	L UTILE	Ø TIGE	PRIX
Tolérance : Ø _{perçage} = + 0 / - 0.004					Ø _{tige} = h6
15060	0.60	30	4.5	1.5	18.30
15070	0.70	30	4.5	1.5	18.30
15075	0.75	30	4.5	1.5	18.30
15080	0.80	30	5.0	1.5	18.30
15085	0.85	30	5.0	1.5	18.30
15090	0.90	30	5.0	1.5	18.30
15091	0.91	30	5.0	1.5	18.30
15094	0.94	30	5.0	1.5	18.30
15095	0.95	30	5.0	1.5	18.30
15100	1.00	30	5.0	1.5	18.30
15104	1.04	30	5.0	1.5	18.30
15105	1.05	30	5.0	1.5	18.30
15110	1.10	30	5.0	1.5	18.30
15115	1.15	30	5.0	1.5	18.30
15120	1.20	30	6.0	1.5	18.30
15125	1.25	30	6.0	1.5	18.30
15130	1.30	30	6.0	1.5	18.30
15135	1.35	30	6.0	1.5	18.30
15140	1.40	30	6.0	1.5	18.30
15145	1.45	30	6.0	1.5	18.30
15148	1.48	30	6.0	2.0	18.30
15150	1.50	38	7.0	2.0	22.20
15155	1.55	38	7.0	2.0	22.20
15158	1.58	38	7.0	2.0	22.20
15160	1.60	38	7.0	2.0	22.20
15165	1.65	38	7.0	2.0	22.20
15170	1.70	38	7.0	2.0	22.20
15175	1.75	38	7.0	2.0	22.20
15178	1.78	38	8.0	2.0	22.20
15180	1.80	38	8.0	2.0	22.20
15185	1.85	38	8.0	2.0	22.20
15190	1.90	38	8.0	2.0	22.20

Conditions de vente, rabais par dimensions :
 5% pour 10 pièces identiques
 10% pour 30 pièces identiques
 15% pour 50 pièces identiques

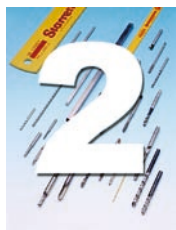

Schurch Asco SA

ASCO
Partenaire et Savoir-faire

AV. DU 1ER MARS 33, CP 3052
CH-2001 NEUCHÂTEL
SUISSE

TÉL : +41 32 724 3434
FAX : +41 32 724 3436
EMAIL : info@schurch-asco.com
WEB : www.schurch-asco.com

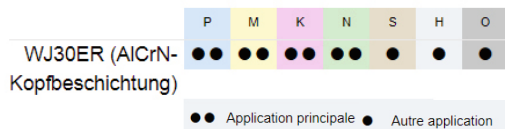
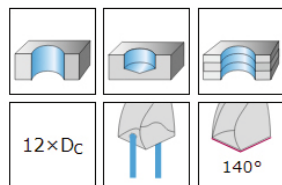

Micro forets en Carbure Monobloc à Lubrification interne

MD

DB133 SUPREME
Longue coupe : 12X D_c

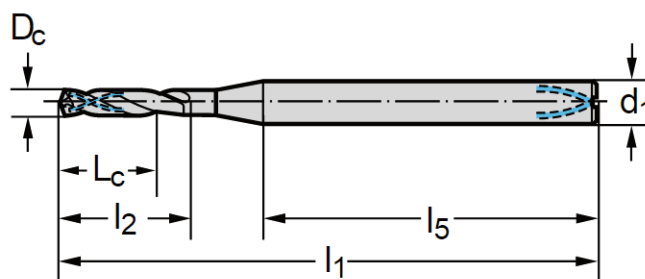

Foret avec lubrification centrale, à haute performance pour micro-perçage dans divers matériaux tels que les aciers inox ou non, la fonte, les métaux non ferreux ou les alliages d'aluminium, de cuivre ou nickel. Ce foret en carbure ultrafin à revêtement microligne autorise un débit de lubrifiant important et possède une géométrie adaptée au perçage profond.

Réf.	D _c	L _c	l ₁	l ₂	l ₅	d ₁	Prix
08614	0.7	9.9	53	11	35	3	176.00
08615	0.75	10.8	53	12	34	3	176.00
08616	0.794	10.8	53	12	34	3	176.00
08617	0.8	10.8	53	12	34	3	176.00
08618	0.85	12.6	57	14	36	3	176.00
08619	0.9	12.6	57	14	36	3	176.00
08620	0.95	14.5	57	16	34	3	176.00
08621	1	14.5	57	16	34	3	176.00
08622	1.05	15	59	17	36	3	176.00
08623	1.1	15	59	17	36	3	176.00
08624	1.15	17	59	19	34	3	176.00
08625	1.191	17	59	19	34	3	176.00
08626	1.2	17	59	19	34	3	176.00
08627	1.25	17	59	19	34	3	176.00
08628	1.3	18	63	20	37	3	176.00
08629	1.35	19	63	22	35	3	176.00
08630	1.4	19	63	22	35	3	176.00
08631	1.45	20	63	23	34	3	176.00
08632	1.5	20	63	23	34	3	176.00
08633	1.55	22	67	25	37	3	176.00
08634	1.588	22	67	25	37	3	176.00

Réf.	D _c	L _c	l ₁	l ₂	l ₅	d ₁	Prix
08635	1.6	22	67	25	37	3	176.00
08636	1.65	23	67	26	36	3	176.00
08637	1.7	23	67	26	36	3	176.00
08638	1.75	25	67	28	34	3	176.00
08639	1.8	25	67	28	34	3	176.00
08640	1.85	26	72	29	38	3	176.00
08641	1.9	26	72	29	38	3	176.00
08642	1.95	28	72	31	36	3	176.00
08643	1.984	28	72	31	36	3	176.00
08644	2	28	72	31	36	3	170.00
08645	2.1	29	72	33	35	3	170.00
08646	2.2	30	72	34	34	3	197.00
08647	2.3	32	77	36	37	3	197.00
08648	2.381	33	77	37	36	3	197.00
08649	2.4	33	77	37	36	3	197.00
08650	2.5	35	77	39	34	3	197.00
08651	2.6	36	83	40	39	3	197.00
08652	2.7	37	83	42	38	3	197.00
08653	2.778	38	83	43	37	3	197.00
08654	2.8	38	83	43	37	3	197.00
08655	2.9	40	83	45	35	3	197.00

Conditions de vente : Rabais 15%.

44 Outils de coupe

Mars 2024



Foret ASCO 1145-HH R

coupe à droite, hélice à 30°, pointe à 140°

MD + TIALN



Ce foret avec lubrification centrale, à revêtement TiAlN autorise un débit de lubrifiant important et tous les avantages qui en découlent. La tolérance du diamètre de perçage est notée en rouge pour la valeur 0/-0.004 et en noir pour la valeur h6. La tolérance sur le diamètre de tige est constante à h6.

Réf.	Ø PERÇAGE	L TOTALE	L UTILE	Ø TIGE	PRIX
17401	0.80	38	5	3	94.80
17407	1.40	38	7	3	94.80
17408	1.50	38	11	3	94.80
17409	1.60	38	11	3	94.80
17410	1.70	38	11	3	94.80
17411	1.80	38	11	3	94.80
17412	1.90	38	11	3	94.80
17413	2.00	38	15	3	94.80
17414	2.10	38	15	3	94.80
17415	2.20	38	15	3	94.80
17416	2.30	50	15	4	94.80
17417	2.40	50	15	4	94.80
17418	2.50	50	18	4	94.80
17419	2.60	50	18	4	94.80
17420	2.70	50	18	4	94.80
17421	2.80	50	18	4	94.80
17422	2.90	60	23	6	94.80
17423	3.00	66	23	6	94.80
17424	3.20	66	23	6	94.80
17425	3.30	66	23	6	94.80
17426	3.40	66	23	6	94.80
17427	3.50	66	23	6	94.80
17428	3.75	74	29	6	96.10
17429	3.80	74	29	6	96.10
17430	4.00	74	29	6	94.80
17431	4.10	74	29	6	96.10
17432	4.20	74	29	6	96.10
17433	4.30	74	29	6	96.10
17434	4.40	82	35	6	96.10
17435	4.50	82	35	6	97.50

Réf.	Ø PERÇAGE	L TOTALE	L UTILE	Ø TIGE	PRIX
17436	4.80	82	35	6	97.50
17437	5.00	82	35	6	97.50
17438	5.10	82	35	6	97.50
17439	5.20	82	35	6	97.50
17440	5.30	82	35	6	97.50
17441	5.50	82	35	6	97.50
17442	5.60	82	35	6	97.50
17443	5.80	82	35	6	97.50
17444	6.00	82	35	6	97.50
17445	6.10	91	43	8	114.00
17446	6.20	91	43	8	114.00
17447	6.30	91	43	8	114.00
17448	6.35	91	43	8	119.90
17449	6.50	91	43	8	114.00
17450	6.60	91	43	8	119.90
17451	6.80	91	43	8	119.90
17452	7.00	91	43	8	114.00
17453	7.20	91	43	8	119.90
17454	7.30	91	43	8	119.90
17455	7.50	91	43	8	119.90
17456	7.60	91	43	8	119.90
17457	7.80	91	43	8	119.90
17458	8.00	91	43	8	114.00
17459	8.10	103	49	10	127.00
17460	8.20	103	49	10	127.00
17461	8.30	103	49	10	127.00
17462	8.50	103	49	10	127.00
17463	8.60	103	49	10	127.00
17464	8.80	103	49	10	127.00
17465	9.00	103	49	10	127.00
17466	9.20	103	49	10	145.90
17467	9.40	103	49	10	145.90
17468	9.50	103	49	10	145.90
17470	9.60	103	49	10	145.90
17471	9.80	103	49	10	138.70
17472	10.00	103	49	10	127.00

Conditions de vente, rabais :
 5 % pour 10 pièces identiques
 10% pour 20 pièces identiques
 12% pour 30 pièces identiques
 15% pour 50 pièces identiques

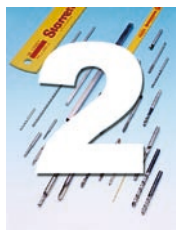

Schurch Asco SA

ASCO
Partenaire et Savoir-faire

AV. DU 1ER MARS 33, CP 3052
CH-2001 NEUCHÂTEL
SUISSE

TÉL : +41 32 724 3434
FAX : +41 32 724 3436
EMAIL : info@schurch-asco.com
WEB : www.schurch-asco.com

Alésoir machine

HSSE DIN 212

Court

HSSE

Echelonnement : 0.01 mm
Tolérance tige cylindrique : h6

Coupe à droite, hélice à gauche, 7 - 8 degré
Plage: 0.60 à 2.65 Tolérance: - 0 / + 0.003 mm
Angle d'entrée: 60°
Plage: 2.66 à 3.75 Tolérance: - 0 / + 0.004 mm
Angle d'entrée: 45°

HSSE + Acurea



Réf.	Prix	Ø ALÉSOIR	L TOTALE	L UTILE	Ø TIGE	Rainures	Réf.	PRIX
09500	52.80	0.60 à 0.79	35	10	1.2	4	09600	68.60
		0.80 à 0.85	40	15				
09501	34.80	0.86 à 1.05	40	15	1.2	4	09601	45.20
09502	33.50	1.06 à 1.18	40	15	1.2	4	09602	43.60
09503	33.50	1.19 à 1.32	40	15	1.2	4	09603	43.60
09504	33.50	1.33 à 1.50	40	15	1.5	4	09604	43.60
09505	33.50	1.51 à 1.70	50	20	2.0	4	09605	43.60
09506	33.50	1.71 à 1.90	50	20	2.0	4	09606	43.60
09507	33.50	1.91 à 2.05	50	20	2.0	4	09607	43.60
09508	29.30	2.06 à 2.12	50	20	2.0	4	09608	42.50
09509	29.30	2.13 à 2.36	50	20	2.5	4	09609	42.50
09510	29.30	2.37 à 2.65	50	20	2.5	4	09610	42.50
09511	26.40	2.66 à 2.75	61	20	2.5	6	09611	38.30
09512	26.40	2.76 à 2.90	61	20	2.5	6	09612	38.30
09513	26.40	2.91 à 3.05	61	20	2.5	6	09613	38.30
09514	26.40	3.06 à 3.20	65	25	3.0	6	09614	42.20
09515	26.40	3.21 à 3.35	65	25	3.0	6	09615	42.20
09516	26.40	3.36 à 3.55	70	25	3.0	6	09616	42.20
09517	26.40	3.56 à 3.75	70	25	3.0	6	09617	42.20

Conditions de vente, rabais par dimensions : 15% pour 5 pièces identiques
20% pour 10 pièces identiques



Echelonnement : **0.01 mm**
Tolérance tige cylindrique : h6

Coupe à droite, hélice à gauche . 7 - 8 degré
Plage: 0.60 à 2.65 Tolérance: - 0 / + 0.003 mm
Angle d'entrée: **60°**
Plage: 2.66 à 20.05 Tolérance: - 0 / + 0.004 mm
Angle d'entrée: **45°**

Alésoir machine

DIN 212

Long

HSSE

HSSE + Acurea



Réf.	Prix	Ø ALÉSOIR	L TOTALE	L UTILE	L TIGE	Ø TIGE	Rainures	Réf.	Prix
09518	29.00	3.76 à 4.05	75	25	32	4.0	6	09618	46.40
09519	29.00	4.06 à 4.25	75	25	32	4.0	6	09619	52.20
09520	30.60	4.26 à 4.55	80	28	32	4.5	6	09620	55.10
09521	30.60	4.56 à 4.75	80	28	32	4.5	6	09621	55.10
09522	31.60	4.76 à 5.05	86	28	34	5.0	6	09622	56.90
09523	31.60	5.06 à 5.30	86	28	34	5.0	6	09623	56.90
09524	33.50	5.31 à 5.55	93	32	36	5.5	6	09624	60.30
09525	33.50	5.56 à 6.05	93	32	36	5.5	6	09625	60.30
09526	34.80	6.06 à 6.70	101	32	38	6.0	6	09626	62.60
09527	36.10	6.71 à 7.05	109	32	40	7.0	6	09627	65.00
09528	36.10	7.06 à 7.55	109	32	40	7.0	6	09628	65.00
09529	37.40	7.56 à 8.05	117	33	42	8.0	6	09629	67.30
09530	37.40	8.06 à 8.50	117	33	42	8.0	6	09630	67.30
09531	37.40	8.51 à 9.05	125	36	42	9.0	6	09631	67.30
09532	42.00	9.06 à 9.50	125	36	42	9.0	6	09632	75.60
09533	42.00	9.51 à 10.05	133	38	44	10.0	6	09633	75.60
09534	46.40	10.06 à 10.60	133	38	44	10.0	6	09634	83.50
09535	46.40	10.61 à 11.05	142	41	44	10.0	6	09635	83.50
09536	61.20	11.06 à 11.80	142	41	44	10.0	6	09636	110.20
09537	61.20	11.81 à 12.05	151	44	44	10.0	6	09637	110.20
09538	80.60	12.06 à 13.20	151	44	44	10.0	6	09638	145.10
09539	98.00	13.21 à 14.05	160	47	50	12.5	8	09639	176.40
09540	98.00	14.06 à 15.05	162	50	50	12.5	8	09640	176.40
09541	99.90	15.06 à 16.05	170	52	50	12.5	8	09641	179.80
09542	123.80	16.06 à 17.05	175	54	52	14.0	8	09642	222.80
09543	123.80	17.06 à 18.05	182	56	52	14.0	8	09643	222.80
09544	123.80	18.06 à 19.05	189	58	58	16.0	8	09644	260.00
09545	126.30	19.06 à 20.05	195	60	58	16.0	8	09645	265.20

Conditions de vente, rabais par dimensions : 15% pour 5 pièces identiques
20% pour 10 pièces identiques

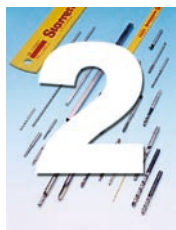

Schurch Asco SA

ASCO
Partenaire et Savoir-faire

AV. DU 1ER MARS 33, CP 3052
CH-2001 NEUCHÂTEL
SUISSE

TÉL : +41 32 724 3434
FAX : +41 32 724 3436
EMAIL : info@schurch-asco.com
WEB : www.schurch-asco.com

Recommandée pour l'usinage à haute vitesse.
Excellents résultats dans de l'acier entre 20 HRC et 50 HRC. Les articles notés en rouge sont disponibles du stock.

Fraise ASCO

7242

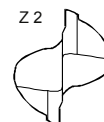

Coupe au centre selon norme : DIN 6527
Durée de vie élevée.

MD

MD + TiAIN



Réf.	Prix	Ø NOMINAL	Ø TIGE	L TOTALE	L UTILE	Rainures	Réf.	Prix
08230	30.60	0.30	3	38	0.6	2	08260	37.00
08231	30.60	0.40	3	38	0.8	2	08261	37.00
08228	31.80	0.45	3	38	1.0	2	08258	38.30
08232	25.30	0.50	3	38	1.0	2	08262	31.80
08233	26.60	0.60	3	38	1.2	2	08263	33.00
08234	26.60	0.70	3	38	1.4	2	08264	33.00
08235	26.60	0.80	3	38	1.6	2	08265	33.00
08236	26.60	0.90	3	38	1.8	2	08266	33.00
08237	21.40	1.00	3	38	2.0	2	08267	27.70
08238	26.60	1.10	3	38	2.2	2	08268	33.00
08239	31.80	1.20	3	38	2.4	2	08269	33.00
08240	26.60	1.30	3	38	2.6	2	08270	33.00
08241	26.60	1.40	3	38	2.8	2	08271	33.00
08242	21.40	1.50	3	38	3.0	2	08272	27.70
08243	26.60	1.60	3	38	3.2	2	08273	33.00
08244	26.60	1.70	3	38	3.4	2	08274	33.00
08245	26.60	1.80	3	38	3.6	2	08275	33.00
08246	26.60	1.90	3	38	4.0	2	08276	33.00
08247	21.40	2.00	3	38	6.0	2	08277	27.70
08248	22.90	2.50	3	38	7.0	2	08278	29.40
08249	31.80	3.00	6	57	7.0	2	08279	39.90
08250	40.20	3.50	6	57	7.0	2	08280	48.30

Conditions de vente :

Rabais par dimensions :
5% pour 10 pièces identiques
10% pour 30 pièces identiques
15% pour 50 pièces identiques



Fraise ASCO

7243

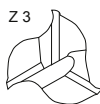

Coupe au centre selon norme : DIN 6527
Durée de vie élevée.

Recommandée pour l'usinage à haute vitesse.
Excellents résultats dans de l'acier entre 20 HRC et 50 HRC. Les articles notés en rouge sont disponibles du stock.

MD



MD + TiAIN



Réf.	PRIX	Ø nominal	Ø tige	L totale	L utile	RAINURES	Réf.	PRIX
08290	25.30	1.00	3.0	38	3.0	3	08320	31.80
08291	31.80	1.25	3.0	38	3.9	3	08321	38.30
08292	25.30	1.50	3.0	38	4.5	3	08322	31.80
08311	33.30	1.70	3.0	38	5.4	3	08341	39.90
08293	32.80	1.75	3.0	38	5.4	3	08323	39.20
08294	24.10	2.00	3.0	38	6.0	3	08324	30.60
08295	24.10	2.50	3.0	38	7.0	3	08325	30.60
08296	32.10	3.00	6.0	57	7.0	3	08326	40.20
08297	39.60	3.50	6.0	57	7.0	3	08327	47.60
08298	34.70	4.00	6.0	57	8.0	3	08328	42.60
08299	41.50	4.50	6.0	57	8.0	3	08329	52.60
08300	36.40	5.00	6.0	57	10.0	3	08330	44.50
08301	41.50	5.50	6.0	57	10.0	3	08331	52.60
08302	30.90	6.00	6.0	57	10.0	3	08332	38.90
08303	55.80	SP 6.00	8.0	63	12.0	3	08333	65.50
08304	62.90	7.00	8.0	63	13.0	3	08334	72.70
08306	45.00	8.00	8.0	63	16.0	3	08336	54.90
08307	82.80	SP 8.00	10.0	63	15.0	3	08337	94.10
08308	91.30	9.00	10.0	72	16.0	3	08338	102.90
08310	53.70	10.00	10.0	72	19.0	3	08340	65.50
08312	80.35	SP 10.00	10.0	72	19.0	3	08342	95.85

**Les fraises de diamètre 6.00 mm et supérieur sont dotées d'un chanfrein.
Les type SP sont sans chanfrein.**

Conditions de vente :

Rabais par dimensions :
5% pour 10 pièces identiques
10% pour 30 pièces identiques
15% pour 50 pièces identiques

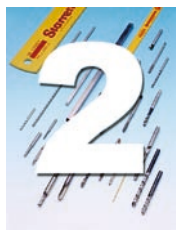

Schurch Asco SA

ASCO
Partenaire et Savoir-faire

AV. DU 1ER MARS 33, CP 3052
CH-2001 NEUCHÂTEL
SUISSE

TÉL : +41 32 724 3434
FAX : +41 32 724 3436
EMAIL : info@schurch-asco.com
WEB : www.schurch-asco.com

Fraise à graver MD FG 911 Hélicoïdal 35°, 3/4

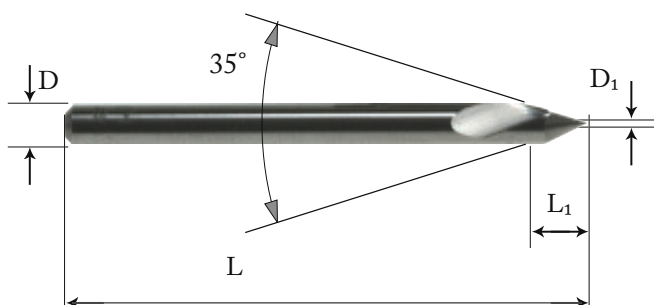

Réf.	D ₁	TOLÉRANCE	L ₁	D	L	PRIX
16166	0.20	± 0.02	4.4	3	38	35.30

Fraise à angler MD 7625 Angles rentrants

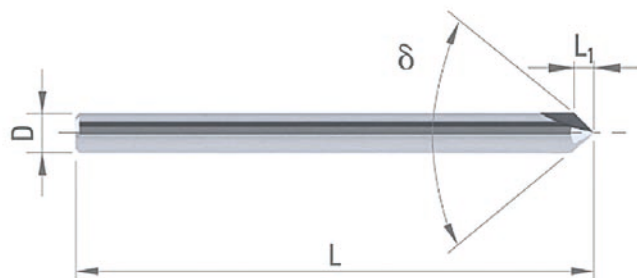

Réf.	L ₁	δ	D _{h5}	L	PRIX
16163	2.60	60 °	3	38	31.10
16164	1.50	90 °			26.60
16165	0.90	120 °			31.10

Fraise à graver MD 7025 Hélicoïdal 60° Execution Terminée

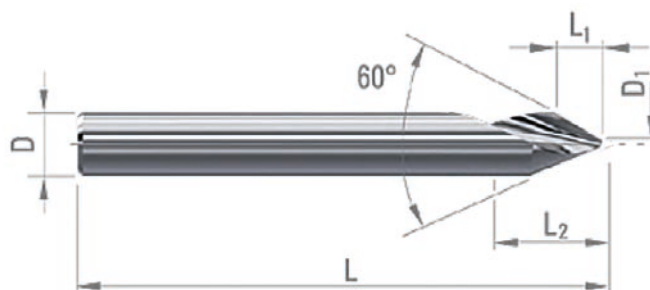

Réf.	D ₁	TOLÉRANCE	L ₂	D _{h5}	L	L ₁	PRIX
16930	0.10	± 0.02	9	3	38	2.50	30.30
16931	0.15	± 0.02	12	4	50	3.30	33.30

Fraise à chanfrein MD 7623 A 90° pour usinage général

D1 e8

∅ < 2.00 | 0 / -0.01

Tol D2 2 ± 0.05

∅ < 3.00 | 0 / -0.02

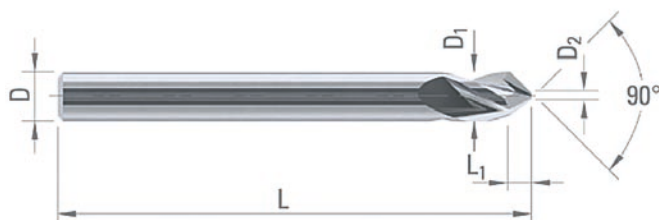

Réf.	D ₁	D ₂	L ₁	D _{h5}	L	PRIX
16920	0.50	0.05	1.5	3	38	29.60
16921	0.80	0.08	1.5	3	38	28.40
16922	1.00	0.10	2.0	3	38	28.40
16923	2.00	0.20	3.0	3	38	29.70
16924	3.00	0.30	5.0	3	38	32.10

Conditions de vente : Prix net.

50 Outils de coupe

Février 2024



Fraise plates à graver MD 7017 1/2 Execution Terminée

Pour gravure de platine de montre, boîte, fond et cadrans

matières à usiner

bien excellent

Acier + Pb	Acier faibl. allié	Acier fort. allié	Acier inox. aust.	Fontes
Super alliages Ni / Co	Titane	Alliage Cu Argent Or	Alliage Cu difficile	Alu
Graphite	Plastique	Or	Argent	

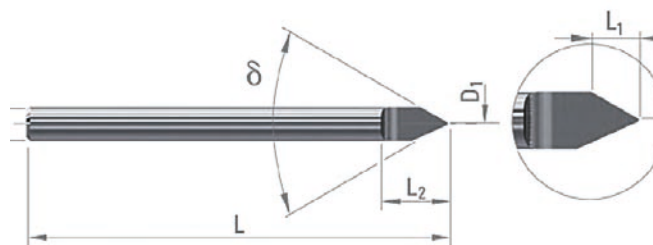

non traitée 60 °

traitée DINAC PVD

Réf.	Prix	PLAT AVANT	L	L ₁	L ₂	D _{h6}	δ	N° Article	Réf.	PRIX
17750	30.40	0.05	38	2.4	6	3	60 °	7017	17760	36.00
17751	28.40	0.08	38	2.4	6	3		7017	17761	34.40
17752	27.40	0.10	38	2.4	6	3		7017	17762	33.10
17753	27.40	0.15	38	2.4	6	3		7017	17763	33.10
17754	27.40	0.20	38	2.4	6	3		7017	17764	33.10
17755	37.70	0.05	50	3.3	8	4		7017	17765	44.00
17756	35.00	0.10	50	3.3	8	4		7017	17766	41.10

non traitée 50 ° | 40 ° | 30 °

traitée DINAC PVD

Réf.	Prix	PLAT AVANT	L	L ₁	L ₂	D _{h6}	δ	N° Article	Réf.	PRIX
17800	30.40	0.05	38	3	6	3	50 °	7017	17815	36.00
17801	27.40	0.08	38	3	6	3	50 °	7017	17816	33.10
17802	27.40	0.10	38	3	6	3	50 °	7017	17817	33.10
17803	27.40	0.15	38	3	6	3	50 °	7017	17818	33.10
17804	27.40	0.20	38	3	6	3	50 °	7017	17819	33.10
17805	30.40	0.05	38	4	4	3	30 °	7017	17820	39.50
17806	27.40	0.10	38	4	4	3	30 °	7017	17821	33.10
17807	27.40	0.15	38	4	4	3	30 °	7017	17822	33.10
17808	27.40	0.20	38	4	4	3	30 °	7017	17823	33.10
17809	52.20	0.20	57	12	8	6	40 °	7017	17824	-

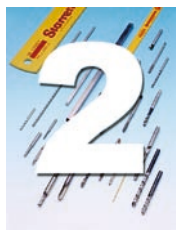

Schurch Asco SA

ASCO
Partenaire et Savoir-faire

AV. DU 1ER MARS 33, CP 3052
CH-2001 NEUCHÂTEL
SUISSE

TÉL : +41 32 724 3434
FAX : +41 32 724 3436
EMAIL : info@schurch-asco.com
WEB : www.schurch-asco.com

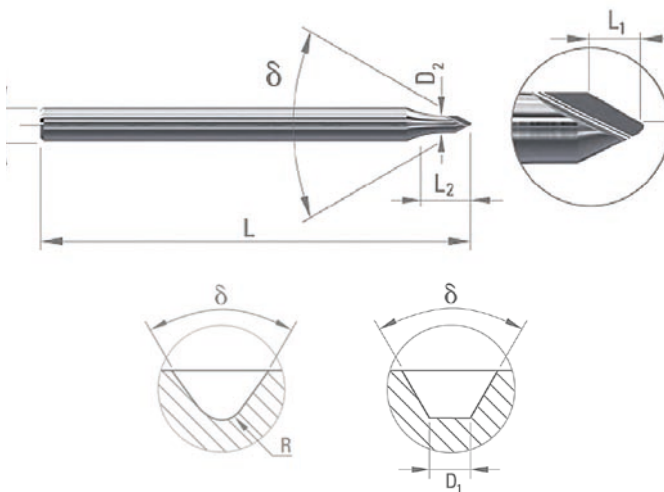

Fraise plate à rayon et à graver

MD 7007

3/4 Execution Terminée

Pour gravure de platine de montre, boîte, fond et cadrans

matières à usiner

○ bien ⊙ excellent

Acier + Pb	Acier faibl. allié	Acier fort. allié	Acier inox. aust.	Fontes 4565 HRC
Fontes	Super alliages Ni / Co	Titane	Alliage Cu Argent Or	Alliage Cu difficile
Alu	Graphite	Plastique	Or	Argent

non traitée 60 ° | 50 ° | 40 ° | 35 ° | 30 ° traitée DINAC PVD

Réf.	Prix	PLAT AVANT	L	L ₁	L ₂	D _{h6}	δ	D ₂	N° Article	Réf.	PRIX
17770	31.80	0.05	38	1.10	2.30	3.0	60 °	1.50	7007	17785	37.50
17771	30.90	0.08	38	1.10	2.30	3.0	60 °	1.50	7007	17786	36.50
17772	30.90	0.10	38	1.10	2.30	3.0	60 °	1.50	7007	17787	36.50
17773	30.90	0.15	38	1.10	2.30	3.0	60 °	1.50	7007	17788	36.50
17774	31.80	0.05	38	1.40	2.30	3.0	50 °	1.50	7007	17789	37.50
17775	30.90	0.08	38	1.40	2.30	3.0	50 °	1.50	7007	17790	36.50
17776	30.90	0.10	38	1.40	2.30	3.0	50 °	1.50	7007	17791	36.50
17777	30.90	0.15	38	1.40	2.30	3.0	50 °	1.50	7007	17792	36.50
17778	31.80	0.05	38	1.70	3.20	3.0	40 °	1.50	7007	17793	37.50
17779	30.90	0.08	38	1.70	3.20	3.0	40 °	1.50	7007	17794	36.50
17830	30.90	0.10	38	1.70	3.20	3.0	40 °	1.50	7007	17845	36.50
17831	30.90	0.15	38	1.70	3.20	3.0	40 °	1.50	7007	17846	36.50
17832	30.90	0.20	38	1.70	3.20	3.0	40 °	1.50	7007	17847	36.50
17833	31.80	0.05	38	2.00	3.40	3.0	35 °	1.50	7007	17848	37.50
17834	30.90	0.08	38	2.00	3.40	3.0	35 °	1.50	7007	17849	36.50
17835	30.90	0.10	38	2.00	3.40	3.0	35 °	1.50	7007	17850	36.50
17836	31.80	0.05	38	2.50	3.40	3.0	30 °	1.50	7007	17851	37.50
17837	30.90	0.08	38	2.50	3.40	3.0	30 °	1.50	7007	17852	36.50
17838	30.90	0.10	38	2.50	3.40	3.0	30 °	1.50	7007	17853	36.50
17839	30.90	0.15	38	2.50	3.40	3.0	30 °	1.50	7007	17854	36.50

non traitée 35 ° traitée DINAC PVD

Réf.	Prix	RAYON AVANT	L	L ₁	L ₂	D _{h6}	δ	D ₂	N° Article	Réf.	PRIX
17840	38.30	0.05	38	1.90	3.4	3.0	35 °	1.50	7007	17855	44.00
17841	35.30	0.10	38	1.90	3.4	3.0	35 °	1.50	7007	17856	40.20
17842	35.30	0.15	38	1.90	3.4	3.0	35 °	1.50	7007	17857	40.20
17843	35.30	0.20	38	1.90	3.4	3.0	35 °	1.50	7007	17858	40.20

Conditions de vente : Net

52 Outils de coupe

Février 2024



Scie machine

STARRETT



HSS TREMPÉ

Réf	Type	Dimension	Dents / 25 mm	Désignation	Prix
02216	à main	300 x 13 x 0.65	24	BS 1224	2.20
02200	machine	300 x 25 x 2.50	10	RS 1210-5	15.00
02201	machine	300 x 25 x 2.50	14	RS 1214-5	15.00
02202	machine	350 x 25 x 2.50	10	RS 1410-5	17.50
02203	machine	350 x 32 x 1.60	6	RS 1406-6	23.50
02204	machine	350 x 32 x 1.60	10	RS 1410-6	23.50
02205	machine	400 x 32 x 2.50	6	RS 1606-6	34.40
02206	machine	400 x 32 x 2.50	10	RS 1610-6	26.90
02207	machine	425 x 32 x 1.60	6	RS 1706-6	28.50
02208	machine	425 x 32 x 1.60	10	RS 1710-6	28.50
02209	machine	450 x 32 x 1.60	6	RS 1806-6	30.20
02210	machine	450 x 38 x 2.00	4	RS 1804-7	32.90
02211	machine	450 x 38 x 2.00	6	RS 1806-7	26.15
02212	machine	450 x 45 x 2.25	4	RS 1804-8	35.70
02213	machine	450 x 45 x 2.20	6	RS 1806-8	35.70
02214	machine	500 x 48 x 2.50	4	RS 1904-0	45.90
02215	machine	525 x 45 x 2.30	6	RS 2106-8	39.30

Conditions de vente : Rabais de 10% sur les prix indiqués

Scie

FEARLESS



HSS TREMPÉ

Réf	Type	Dimension	Dents / 25 mm	Prix	Prix / 10 pièces
02220	machine	300 x 32 x 1.60	6	13.50	121.00
02221	machine	350 x 38 x 1.90	4	13.50	121.00
02222	machine	350 x 38 x 1.90	6	13.50	121.00
02223	machine	425 x 32 x 1.60	4	16.50	148.00
02219	à main	300 x 13 x 0.65	Progressif	2.60	26.00
02224	machine	450 x 32 x 1.60	10	17.50	155.00
02225	machine	450 x 45 x 1.40	4	28.00	253.00
02226	machine	450 x 45 x 2.20	6	28.00	253.00
02227	machine	530 x 38 x 1.90	6	36.00	325.00

Conditions de vente : Rabais de 15% sur les prix indiqués

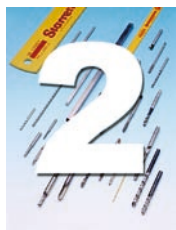

Schurch Asco SA



Partenaire et Savoir-faire

AV. DU 1ER MARS 33, CP 3052
CH-2001 NEUCHÂTEL
SUISSE

TÉL : +41 32 724 3434
FAX : +41 32 724 3436
EMAIL : info@schurch-asco.com
WEB : www.schurch-asco.com

Barreau ASCO **HSS-ES** *Trempés et rectifiés*



G20 SECTION CARRÉ ISO 5421 / 77 Tolérance h13

Réf.	Dimension	Prix
00821	5 x 150	71.50
00823	7 x 200	25.20
00824	8 x 200	35.00
00825	10 x 200	38.30
00826	12 x 200	42.00



G20 SECTION RECTANGULAIRE ISO 541 / 77 Tolérance h13

Réf.	Dimension	Prix
00827	4 x 2 x 60	13.00
00828	4 x 2.2 x 60	13.00



HSS-E-PM SECTION RONDE Tolérance h7

Réf.	Dimension	Prix
00829	0.90 x 35	2.00
00830	1.00 x 35	2.00
00831	1.10 x 35	2.00
00832	1.20 x 35	2.00
00833	1.30 x 35	2.00
00834	1.40 x 35	2.00
00835	1.50 x 35	2.00

Conditions de vente :

Rabais de 10 % sur les prix indiqués par commande minimum de 100 pièces sur les barreaux ronds uniquement.